



Ultra Low Noise Power Supply

Ultra-high efficiency 1U size



PLUG & PLAY POWER next generation power solution

FEATURES & OPTIONS

- Low Acoustic noise 37.3dBA
- Ultra high efficiency, up to 89%
- Extra low profile: 1U height (40mm)
- Plug & Play Power - allows fast custom configuration
- Individual output control signals
- All outputs fully floating
- Series / Parallel of multiple outputs
- Few electrolytic capacitors (all long life)
- Visual LED indicators
- 5V bias standby voltage provided
- Standard Xgen product options include: Conformal Coating, Low Acoustic Noise, Low Leakage Current, Extra Ruggedisation, Connector, Cabling & Mounting options, Thermal Signals and Reverse Fans. See Section 4.10 for more information

APPLICATIONS INCLUDE

- Audio Equipment
- Test and measurement
- Telecommunications
- For Medical applications, See XN

The XT family of Ultra Low Noise power supplies provides up to 400W in an extremely compact 1U x 260mm x 89mm package. With efficiencies of up to 90%, the XT family employs an innovative plug & play architecture that allows users to instantly configure a custom power solution in less than 5 minutes!

Ideal for acoustic sensitive applications such as audio applications, the XT family provides unmatched efficiency and high power density, made possible through the combination of low loss technologies and the best field-proven technologies in planar magnetics and surface mount electronics.

The XT family consists of 2 *powerPac* models ranging in power levels from 200W to 400W. Each model may be populated with up to 4 *powerMods* selected from the table of *powerMods* shown below.

All configurations carry full safety agency approvals, UL60950, EN60950 and are CE marked.

powerMods

MODEL	Vmin Vtrim	Vnom Vpot	Vmax	Imax	Watts
Xg1	1.0	1.5	2.5	3.6	41.6A 104W
Xg2	1.5	3.2	5.0	6.0	33.2A 166W
Xg3	4.0	6.0	12.0	15.0	16.67A 200W
Xg4	8.0	12.0	24.0	30.0	8.33A 200W
Xg5	8.0	24.0	48.0	5A	240W
Xg7		5.0	24.0	28.0	4.17A 100W
Xg8 v1		5.0	24.0	28.0	2.5A 60W
v2		5.0	24.0	28.0	2.5A 60W

powerPacs

	MODEL	Watts
XT	XTA	200W
	XTB	400W

powerMod Maximum Power Outputs (W) have been derated to operate with XT range of Ultra Low-Noise Power Supplies. See Section 4.11 Xgen Designers Manual for full derating details.

EFFICIENCY (typical)

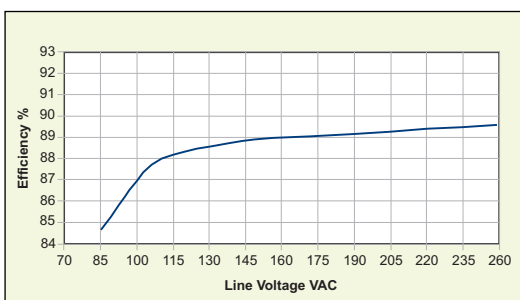

MECHANICAL SPECIFICATIONS

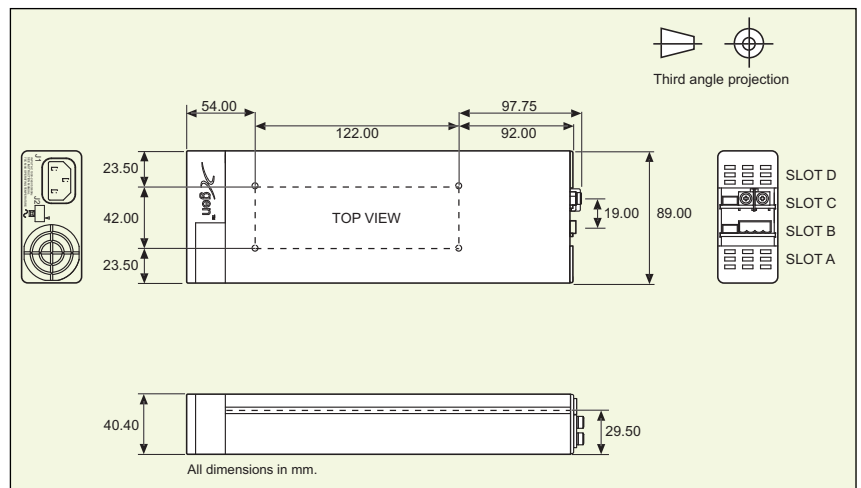

SPECIFICATION applies to configured units consisting of *powerMods* plugged into the appropriate *powerPac*

INPUT					
Parameter	Conditions/Description	Min	Nom	Max	Units
Input Voltage Range	Universal Input 47-63Hz. Contact factory for 440Hz operation	85 120		264 380	VAC VDC
Power Rating	XTA:200W, XTB:400W See Section 4.11 for line voltage deratings				
Input Current XTA XTB	85VAC in 200W out 85VAC in 283W out		4.5 5.0		A A
Inrush Current	230VAC, 25°C			50	A
Undervoltage Lockout	Shutdown	65		74	VAC
Fusing XTA XTB	250V 250V		F5A HRC F6.3A HRC		
OUTPUT					
Parameter	Conditions/Description	Min	Nom	Max	Units
powerMod Power	As per <i>powerMod</i> table				
Output Adjustment Range	Manual: Multi-turn potentiometer. As per <i>powerMod</i> table Electronic: See Section 4.6				
Minimum Load			0		A
Line Regulation	For ±10% change from nominal line			±0.1	%
Load & Cross Regulation	For 25% to 75% load change			±0.2	%
Transient Response	For 25% to 75% load change Voltage Deviation Settling Time			10 250	% µs
Ripple and Noise	20MHz 100mV or 1.0% pk-pk				
Overvoltage Protection	1st level: Vset Tracking. 2nd level: Vmax (Latching)	110		125	%
Overcurrent Protection	Straight line with hiccup activation at <30% of Vnom See Section 4.6	110		120	%
Remote Sense	Max. line drop compensation. (except Xg7, Xg8)			0.5	VDC
Overshoot				2	%
Turn-on Delay	From AC In / Enable signal			600 / 30	ms
Rise Time	Monotonic			5	ms
Hold-up Time	For nominal output voltages at full load. XTA & XTB	20 / 15			ms
Output Isolation	Output to Output / Output to Chassis	500 / 500			VDC
GENERAL					
Parameter	Conditions/Description	Min	Nom	Max	Units
Isolation Voltage	Input to Output Input to Chassis	3000 1500			VAC VAC
Efficiency	230VAC, 800W @ 24V		90		%
Safety Agency Approvals	EN60950, UL60950, CSA22.2 No.950 UL File No. E181875				
Leakage Current	250VAC, 60Hz, 25°C			1.5	mA
Signals	See Section 4.9				
Bias Supply	Always on. Current 250mA. 500mA option available	4.8	5.0	5.2	VDC
Reliability	Failures per million hours at 25°C and full load <i>powerMod</i> See Section 4.12. <i>powerPac</i> excludes fans <i>powerPac</i>			0.98 0.92	fpmh fpmh
EMC					
Parameter	Standard	Level		Units	
Emissions					
Conducted	EN55011, EN55022, FCC		Level B		
Radiated	EN55011, EN55022, FCC		Level B		
Harmonic Distortion	EN61000-3-2 Class A		Compliant		
Flicker & Fluctuation	EN61000-3-3		Compliant		
Immunity					
Electrostatic Discharge	EN61000-4-2		Level 2		
Radiated Immunity	EN61000-4-3		Level 3		
Fast Transients-Burst	EN61000-4-4		Level 3		
Input Line Surges	EN61000-4-5		Level 3		
Conducted Immunity	EN61000-4-6		Level 3		
Voltage Dips	EN61000-4-11		Compliant		
ENVIRONMENTAL					
Parameter	Conditions/Description	Min	Nom	Max	Units
Operating Temperature		-20		+70	°C
Storage Temperature		-40		+85	°C
Derating	See Section 4.11 for full temperature deratings				
Relative Humidity	Non-condensing	5		95	%RH
Acoustic Noise	Measured from distance on 1m		37.3		dB(A)
Shock	3000 Bumps, 10G (16ms) half sine				
Vibration	1.5G	10		200	Hz

NOTES

1. This product is not intended for use as a stand alone unit and must be installed by qualified personnel.
2. The specifications contained herein are believed to be correct at time of publication and are subject to change without notice.
3. All specifications at nominal input, full load, 25°C unless otherwise stated.
4. When powering inductive or capacitive loads, it is recommended to use a blocking diode on the output.
5. Conformal Coating option: See Sections 3.1 and 4.10 for details.
6. For section references above go to the Xgen Designers Manual.

Xgen Flexibility and Signals

For detailed information please refer to the Xgen Designers' Manual which is available on-line or contact Excelsys.

Voltage Adjustment

Output voltage can be adjusted in a number of ways:

1. On board multi turn potentiometer
2. Remote resistive programming (via Vtrim pin)
3. Remote voltage programming (via Vtrim pin)

Current Limit Adjustment

Output current limit can be Straight line or Foldback and can be adjusted via Itrim pin.

Parallel Connection

To achieve increased current capacity, simply parallel outputs using the standard parallel links.

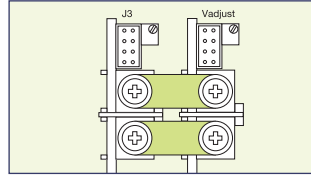

Parallel Links available to order.
Part Number XP1

Series Connection

To achieve increased output voltages, simply series outputs using standard series links, paying attention to the requirements to maintain SELV levels if required in your system.

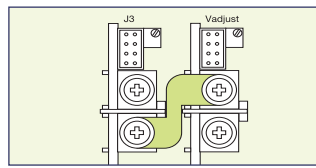

Series Links available. Part Number XS1

Remote Sensing

When the load is remote from the power supply, the remote sense pins may be used to compensate for drops in the power leads. Where the power cabling contributes significant dynamic impedance, see Xgen series Designers' Manual.

Bias Voltage

A SELV isolated bias (always on) voltage of 5V @ 250mA (30mA on XCE and XVE models) is provided on J2 pin 2 relative to J2 pin 1 (common) and may be used for miscellaneous control functions. 5V @ 500mA available on request.

Inhibit/Enable

Inhibiting may be implemented either globally or on a per module basis (*powerPac* or *powerMod* inhibiting). Reverse logic (enabling) may also be implemented.

AC Fail

Open collector signal indicating that the input voltage has failed or is less than 80Vac. This signal changes state giving 5ms of warning before loss of output regulation.

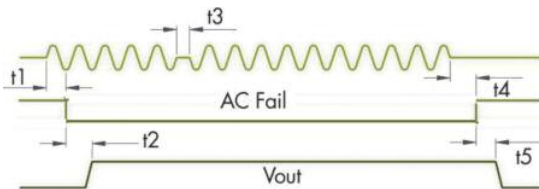

Power Good

Opto-isolated output signal indicates that the *powerMod* is operating correctly and output voltage is within normal band.



powerPac Options

Temperature Alarm (Option 01)

Open collector signal indicating that excessive temperature has been reached due to fan failure or operation beyond ratings. This signal is activated at least 10ms prior to system shutdown.

Fan Fail (Option 01)

Open collector signal indicating that at least one of the *powerPac* fans has failed. This does not cause power supply shutdown. The power supply will continue to operate until 10ms after the temperature alarm signal is generated.

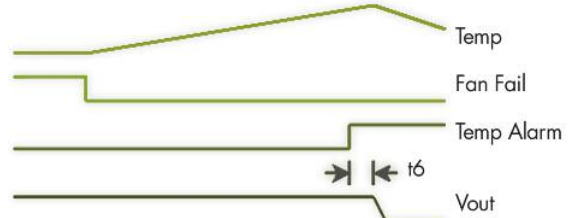

Reverse Fan (Option 02)

The Xgen series is available with reverse air flow direction. Contact Excelsys for derating details.

Ultra Low Leakage current (Option 04)

The Xgen is available with the option of Ultra Low Earth Leakage Current of <math><150\mu\text{A}</math> and is approved to EN60601-1 and UL60601-1 2nd and 3rd Editions.

Conformal Coating (Option C)

Xgen is available with conformal coating for harsh environments and MIL-COTs applications.

Ruggedised Option (Option R)

Xgen is available with extra ruggedisation for applications that are subject to extremes in shock and vibration.

Input cable Option (Option D)

3 Wire input mains cable. Input cables are 300mm in length and come supplied with fast on connectors.

Signal Connector Pinout

Pin	J2 (<i>powerPac</i>)	J3 (<i>powerMod</i>) Type A	J3 (<i>powerMod</i>) Type B
1	common	+sense	+pg (V2)
2	+5V bias	-sense	-pg (V2)
3		V trim	inhibit (V2)
4	ac fail	I trim	common (V2)
5	fan fail*	+inhibit/enable	+pg (V1)
6	global enable	-inhibit/enable	-pg (V1)
7	temp alarm*	+power good	inhibit (V1)
8	global inhibit	-power good	common (V1)

*Option 01 only

TYPE A Xg1-Xg7

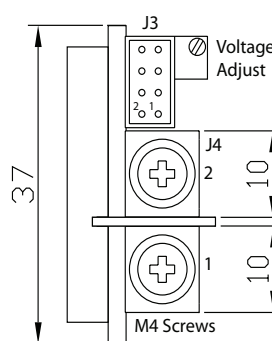

J4 Connector : M4 Screw

J3 Connector Mating Connector
Housing: Locking Molex 51110-0860
Non Locking Molex 51110-0850
Crimp Terminal: Molex p/n 50394

TYPE B : Xg8

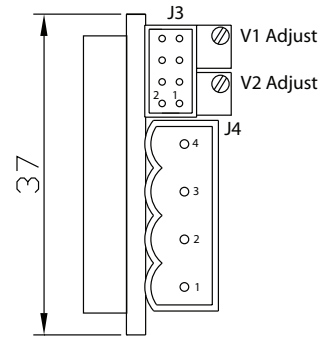

J4Connector : Camden 9200/4A

J3 Connector Mating Connector
Housing: Locking Molex 51110-0860
Non Locking Molex 51110-0850
Crimp Terminal: Molex p/n 50394

Xgen Product Selector

The Xgen series of user configurable power supplies with its unique plug and play architecture allows system designers to define and build 'instant' custom power solutions with industry leading 17W/in³ power density and up to 90% efficiency.

Xgen powerPacs

The application specific 4 slot and 6 slot *powerPacs* provide up to 12 isolated DC outputs from 200W up to 1340W. The table below summarises the *powerPacs* by application and power level. Please refer to the specific product datasheets for full specifications.

Application	Slots	200W	400W	600W	700W	750W	800W	900W	1000W	1200W	1340W
Standard	4 Slot	XLA	XLB	XLC		XLD					
	6 Slot		XCA		XCB				XCC	XCD	XCE
Medical	4 Slot	XMA	XMB	XMC		XMD					
	6 Slot		XVA		XVB				XVC	XVD	XVE
Low Noise Standard	4 Slot	XKA	XKB	XKC							
	6 Slot			XQA				XQB		XQC	
Low Noise Medical	4 Slot	XRA	XRB	XRC							
	6 Slot			XZA				XZB		XZC	
Ultra Quiet Standard	4 Slot	XTA	XTB								
	6 Slot		XBA	XBB			XBC				
Ultra Quiet Medical	4 Slot	XNA	XNB								
	6 Slot		XWA	XWB			XWC				
Hi-Temp	6 Slot		XHA	XHB							

Xgen powerMods

High Efficiency Plug and Play DC output modules to provide a wide range of DC output voltages from 1.0V up to 58.0V.

MODEL	Vmin Vtrim	Vnom Vpot	Vmax	I _{max}	Watts
Xg1	1.0	1.5	2.5	3.6	50A 125W
Xg2	1.5	3.2	5.0	6.0	40A 200W
Xg3	4.0	6.0	12.0	15.0	20A 240W
Xg4	8.0	12.0	24.0	30.0	10A 240W
Xg5	8.0	24.0	48.0	58.0	6A 288W
Xg7		5.0	24.0	28.0	5A 120W
Xg8 v1		5.0	24.0	28.0	3A 72W
v2		5.0	24.0	28.0	3A 72W

Standard Xgen product options include: Conformal Coating, Low Acoustic Noise, Low Leakage Current, Extra Ruggedisation, Connector, Cabling & Mounting options, Thermal Signals and Reverse Fans.



Configuring your Xgen

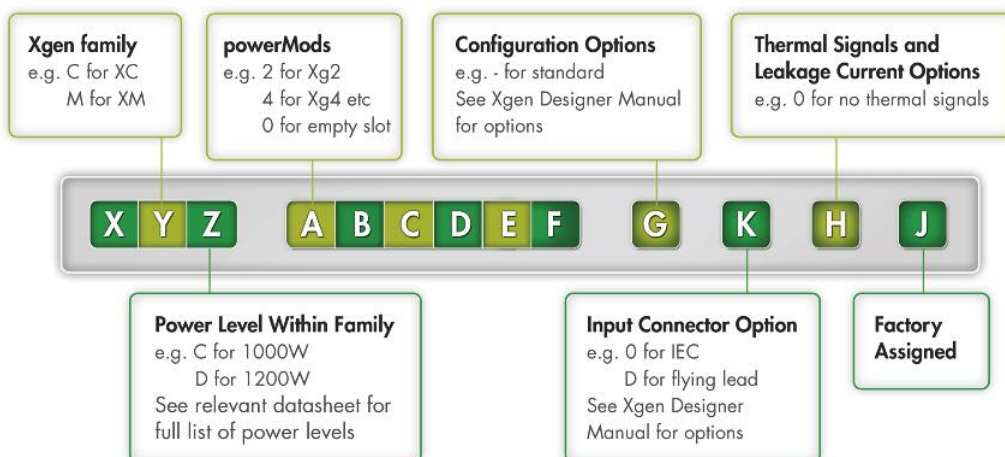

Example:

XVD234580-D4A contains

XVD *powerPac*:

1200W medically approved

Powermods

- Xg2:5V/40A,
- Xg3:12V/20A,
- Xg4:24V/10A,
- Xg5:48V/6A,
- Xg8:24V/3A, 24V/3A

Option D : Input cable option

Option 4: 150µA leakage current option

A: Factory assigned unique identifier